

Intermetallic compounds formed during brazing of titanium with aluminium filler metals

TADASHI TAKEMOTO, IKUO OKAMOTO

Welding Research Institute, Osaka University, Ibaraki, Osaka 567, Japan

The effect of aluminium filler metal composition on the formation of Al-Ti intermetallic compounds was investigated in brazed aluminium-to-titanium (Al/Ti) joints and titanium-to-titanium (Ti/Ti) joints. The clearance filling ability was also studied. In Ti/Ti joints, the thickness of the intermetallic compound layer was strongly dependent on the aluminium filler metal composition, whereas the clearance filling ability was independent of the composition. The maximum intermetallic compound layer thickness was observed in 99.99% highly pure aluminium filler metal; therefore all additional elements reduced the layer thickness. Above all, the addition of 0.8% Si greatly reduced the thickness. After brazing at 680°C for 3 min, the intermetallic compound formed by Al-0 to 0.8% Si filler metal was found to be of type Al_3Ti . Other compounds, of types Ti_9Al_{23} and $Ti_7Al_5Si_{12}$, were also found in joints brazed by Al-3 to 10% Si filler metals. Al-0.8% Si filler metals maintained a higher joint strength than pure aluminium filler metal under brazing conditions of high temperature and long heating time. In Al/Ti joints, Al-Cu-Sn and Al-Cu-Ag filler metal mainly formed Al_3Ti , and Al-10Si-Mg filler metal mainly formed $Ti_7Al_5Si_{12}$ at the brazed interface of the titanium side after brazing at 600 to 620°C.

1. Introduction

Titanium and its alloys have been widely used for air-plane and space activities since they have high specific strength and high corrosion resistance. The joining of titanium may be performed by fusion welding, brazing, diffusion bonding and adhesive bonding. Above all, brazing is beneficial to join many contact points simultaneously without severe distortion, so that brazing has been widely adopted in the production of heat exchangers (fin-to-plate) and honeycomb sandwich structures. The brazing of titanium alloys has been performed using silver filler metals [1-3], titanium-based filler metals [4, 5] and copper filler metals [6]. Recently A3003 aluminium alloy was found to be applicable for the brazing of titanium [7]. However, precise data for microstructure at the brazed interface, joint strength and brazability were not sufficiently clear.

In titanium brazing, as easily estimated from the binary phase diagram [8], almost all the filler metals now available form intermetallic compounds with titanium. Therefore, in the brazing of titanium the compounds formed and the microstructure at the brazed interface have a great influence on the reliability of joints. In addition, brazability would depend on the composition of the filler metals and the brazing conditions. This report deals with the effect of aluminium filler metal composition on the formation of Al-Ti intermetallic compounds, the brazability and the joint strength of titanium base metal.

2. Experimental procedures

Pure titanium plate with 1 mm thickness was used as

a base metal. The composition of impurity elements in titanium is as follows: 0.066% Fe, 0.0038% N, 0.074% O, 0.0018% H. Commercial aluminium alloys and laboratory-made high-purity binary aluminium alloys were used as filler metals. High-purity binary aluminium alloys were made from 99.99% aluminium and high-purity metals. The amount of additional elements was fixed to about 1 wt %. The filler metals were cut and polished to a size of $5\text{ mm} \times 5\text{ mm} \times 2\text{ mm}$. Before brazing, titanium base metal was immersed in nitric acid-fluoric acid aqueous solution to remove surface oxides, and then rinsed sufficiently in tap water.

The thicknesses of intermetallic compounds were measured using the clearance filling test specimen shown in Fig. 1a. Vertical and horizontal members were wound with fine stainless steel wires and a clearance was made by setting a stainless steel spacer with 1.5 mm diameter at one end. Aluminium filler metal was set at the other end of the vertical member. In Al/Ti joints, A1100 aluminium plate was used as a vertical member and the horizontal member was titanium.

After brazing, the thickness of the intermetallic compound layer was measured at the cross-section of the centre ($F_L/2$) of the filled clearance length F_L parallel to the longitudinal direction. Microscopic observation, wave-dispersive X-ray (WDX) line analysis and energy-dispersive X-ray (EDX) line analysis were also made on this section. Prior to cutting the specimen, the filled clearance length F_L was measured. Brazability is considered to be better with longer F_L .

To identify the intermetallic compounds, X-ray

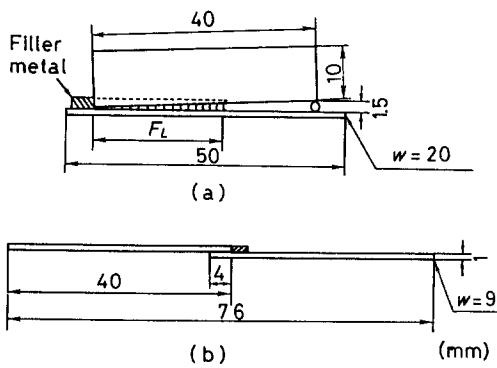

Figure 1 Shape and size of (a) clearance-filling test specimen and (b) tensile test specimen; intermetallic compound layer thickness was measured at the cross-section at $F_L/2$.

diffraction analysis ($\text{CuK}\alpha$, 40 kV, 20 mA) was made on the horizontal member after cutting the vertical member. X-ray diffraction analysis was repeated for several times by polishing the horizontal member until clear diffraction lines of α -titanium appeared.

The joint strength was measured by the lap test-piece shown in Fig. 1b for a Ti/Ti joint. In Al/Ti joints, one member was A3003 aluminium plate with 3 mm thickness. The amount of filler metal used was 0.03 g and was three times larger than the volume of the gap between the lap clearance; the gap was maintained at 0.1 mm with titanium spacers. Prior to the tensile test, the filler was removed by machining. The initial width was 10 mm for each joint. After brazing, the width was adjusted to 9 mm by machining. Tensile tests were performed by an Instron-type tensile test machine under a crosshead speed of 1 mm min^{-1} (the length between chucks was 45 mm). Brazing were carried out under a vacuum level of $2.7 \times 10^{-3} \text{ Pa}$.

3. Results and discussion

3.1. Al/Ti joints

Based on the spread test on titanium base metal at 630°C for 3 min, three filler metal systems, Al–Cu–Sn, Al–Ag–Cu and Al–Si–Mg were selected for making Al/Ti braze joints. In fact, Al–10 to 12.5Cu–5 to 8Sn, Al–10 to 30Ag–10Cu and Al–10Si–0.5 to 2Mg filler metals showed a relatively good filled clearance lengths, 18 to 22 mm at 600 to 620°C for 3 to 5 min. To avoid severe erosion of aluminium base metal by molten filler metal, brazing at liquidus temperature is recommended for Al–Cu–Sn and Al–Ag–Cu filler metals.

Fig. 2 shows the X-ray diffraction lines of Al/Ti brazed interface at the titanium base metal side. The X-ray patterns in the top row of Fig. 2 show examples of a few micrometres further from the titanium base metal than the bottom row. Therefore the compounds with clearer diffraction lines in the bottom row are found closer to the titanium base metal. The aluminium filler metals consisted of solid solution and intermetallic compounds for Al–10Cu–8Sn and Al–30Ag–10Cu, and aluminium solid solution and silicon for Al–10Si–1Mg after brazing. The main compounds formed by brazing were Al_3Ti in the case of Al–10Cu–8Sn and Al–30Ag–10Cu filler metals, and $\text{Ti}_7\text{Al}_5\text{Si}_{12}$ for Al–10Si–1Mg.

Only a few very weak diffraction lines corresponding to $\text{Ti}_8\text{CuAl}_{23}$ and $\text{Ti}_9\text{Al}_{23}$ were observed in Al–10Cu–8Sn and Al–10Si–1Mg, respectively. The amounts of these compounds were expected to be small.

In Al–Ag–Cu filler metals, the formation of $\text{Ti}_9\text{Al}_{23}$ is expected; however, the main diffraction line coincided with the line of Ag_2Al . Therefore $\text{Ti}_9\text{Al}_{23}$

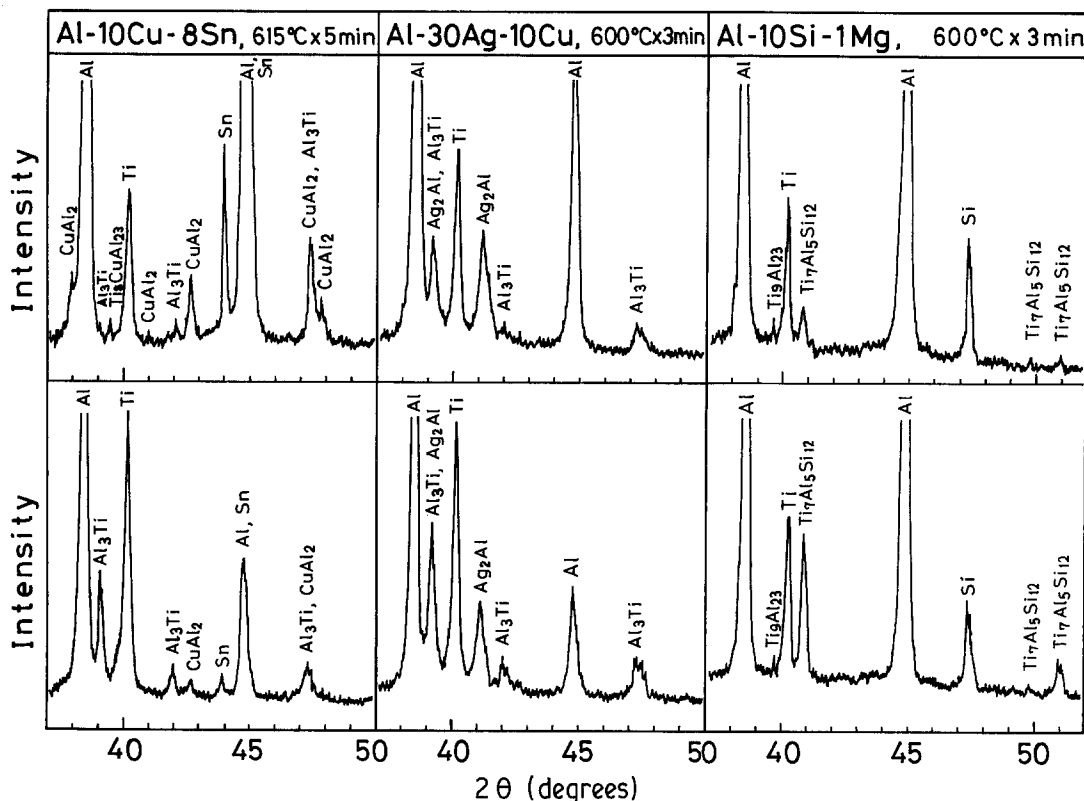

Figure 2 X-ray diffraction lines ($\text{CuK}\alpha$) from brazed interfaces of Al/Ti joints at the titanium base-metal side. Diffraction patterns in the bottom row are several micrometres closer to the titanium base metal than in the top row.

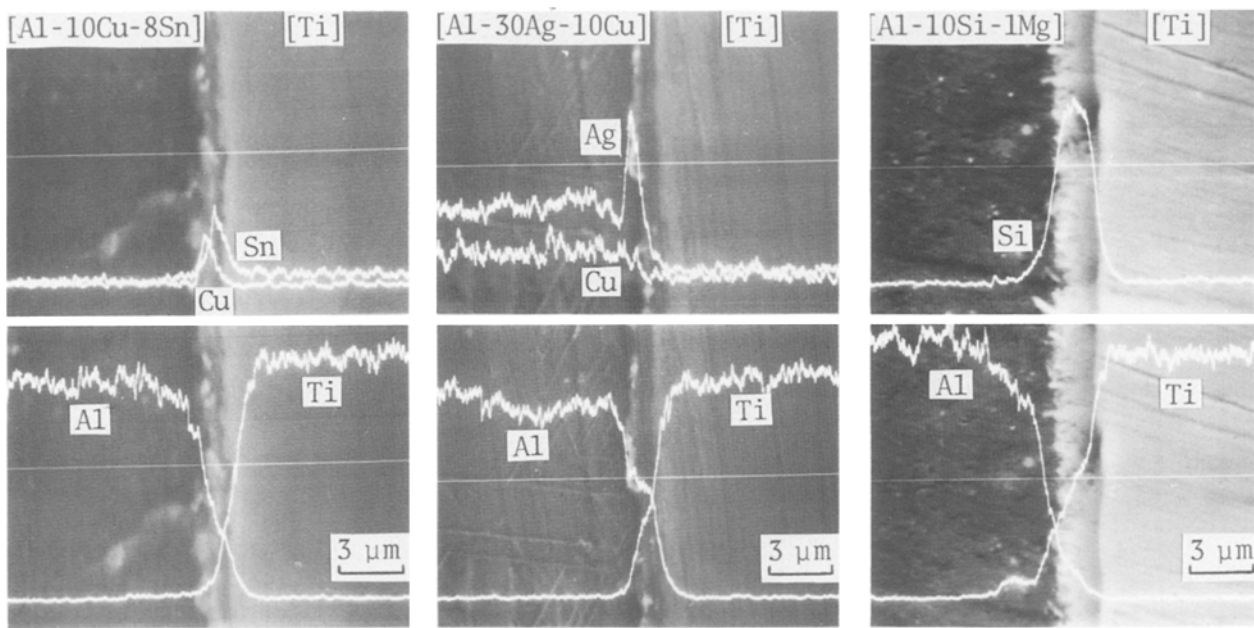

Figure 3 SEM and EDX line analyses on cross-sections of the titanium base-metal sides of Al/Ti joints.

was not identified in Al–Ag–Cu filler metals. The main diffraction line of Ti_8CuAl_{23} appears at a slightly lower angle than Ti_9Al_{23} . The results indicated that the line in Al–Cu–Sn appeared at a slightly lower angle than in Al–10Si–1Mg. The compounds are therefore expressed as Ti_8CuAl_{23} in Fig. 2; however, the possibility of Ti_9Al_{23} remains.

The tensile shear strength of Al/Ti joints brazed with Al–10Cu–8Sn, Al–30Ag–10Cu and Al–10Si–1Mg were 38, 38 and 70 $N\,mm^{-2}$, respectively. The fracture occurred within intermetallic compounds in Al–Cu–Sn and Al–Ag–Cu filler metals. In Al–10Si–1Mg filler metal, fracture occurred in the filler metal.

Other filler metals, Al–33Cu and Al–33Ag, also formed Al_3Ti at the titanium base metal after brazing at 630°C for 3 min.

Fig. 3 shows the scanning electron micrograph (SEM) and EDX line analysis on a cross-section at the brazed interface. Adjacent to Al_3Ti , phases with copper and tin or silver and copper were observed in Al–10Cu–8Sn and Al–30Ag–10Cu, respectively. The phases are expected to be the phases originally existing in the filler metals; however, the possibility of reacted compounds remains. The layer thickness was largest in Al–10Si–1Mg filler metal, but the maximum Al/Ti joint strength was achieved in this filler metal as mentioned above.

3.2. Ti/Ti joints

3.2.1. Aluminium filler metal composition

Table I shows the thickness of the intermetallic compound layer after brazing with various aluminium filler metals. The brazing conditions were 680°C for 3 min. The thickness of the compound layer was quite different with different filler metal compositions. The largest thickness was observed in pure aluminium (99.99% Al), suggesting that all additional and impurity elements for aluminium suppressed the growth of intermetallic compounds, i.e. no elements additional to aluminium would enhance the growth

rate. Nickel addition has little effect on the suppression of the intermetallic compound layer.

The filled clearance length of each filler metal was 25 to 28 mm under the brazing condition of 680°C for 3 min, indicating no dependence on filler metal composition. The appearance of the filler was excellent, smooth and continuous without any surface defects. However, in pure aluminium, Al–1Mg and Al–1Zr filler metals, a thin filler metal layer spread relatively widely on the titanium base metal.

Since Al–0.8Si alloy and commercial alloys, which usually contain 0.2 to 0.6% Si as an impurity element, showed extremely thin intermetallic compound layers (Table I), the addition of silicon to aluminium filler metal seems to be the most effective. Therefore the effect of silicon addition was investigated using high-purity binary Al–Si filler metals.

TABLE I Effect of aluminium filler metal composition on the thickness of intermetallic compound layer formed at brazed interface and filled clearance length (F_L), brazed at 680°C for 3 min

Filler metal	Intermetallic compound layer	
	Thickness (μm)	F_L (mm)
Pure Al	13.3	26.8*
A1100	3.1	26.8
A2017	2.6	25.0
A3003	2.8	25.5
A5005	4.0	27.5
Al–0.8Si	2.6	25.0
Al–1Mg	6.1	27.0*
Al–1Ge	7.3	25.9
Al–1Cu	7.9	26.8
Al–0.5Li	8.9	26.4
Al–1Sb	9.3	25.5
Al–1Fe	9.7	26.6
Al–1Mn	10.1	25.8
Al–1Ti	10.2	26.5
Al–1Zr	11.5	27.5*
Al–1Ni	12.7	27.2

*Filler metals spread relatively widely on titanium base metal.

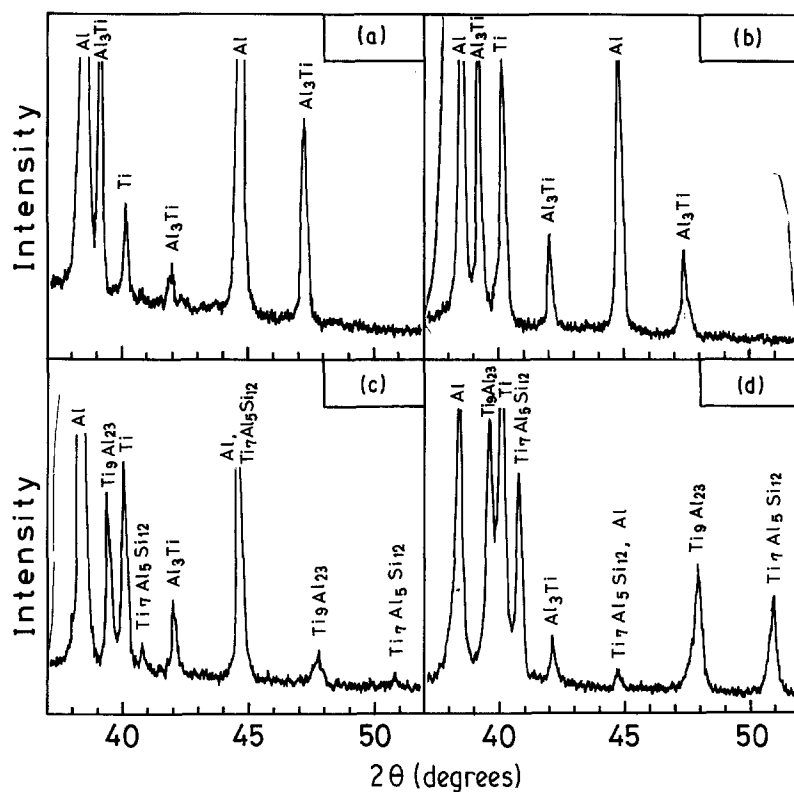

Figure 4 X-ray diffraction lines (CuK α) from brazed interfaces on titanium base metal brazed with various aluminium filler metals, brazed at 680°C for 3 min. (a) Pure aluminium, (b) Al-0.8Si, (c) Al-3Si, (d) Al-10Si.

Table II shows the effect of silicon content on the thickness of the intermetallic compound layer after brazing at 680°C for 3 min. The intermetallic compound layer thickness was a maximum in pure aluminium filler metal. The addition of 0.1% Si remarkably reduced the layer thickness and the minimum value was obtained at 0.8% Si in the present work. The X-ray diffraction lines (CuK α) at the brazed interface on titanium base metal are indicated in Fig. 4. The compound layer was of type Al₃Ti up to 0.8% Si. Further addition increased the layer thickness, and other compounds such as types Ti₉Al₂₃ and Ti₇Al₅Si₁₂ coexisted in Al-3Si and Al-10Si. A repeated experiment after polishing the layer by several micrometres revealed that the compound adjacent to the titanium base plate side was Ti₇Al₅Si₁₂. A small addition of silicon into aluminium filler metal is confirmed to be highly effective for suppressing the growth of intermetallic compound of type Al₃Ti.

Figs 5 and 6 are SEM and EDX line analyses of titanium and aluminium at interfaces brazed with pure aluminium and Al-0.8% Si filler metal, respectively. As shown in Table II, the thickness of Al₃Ti-type compound is larger in pure aluminium than in Al-0.8Si filler metal. Silicon is detected in the intermetallic compound, type Al₃Ti. Silicon was also

detected in Al₃Ti brazed with Al-0.1Si, and not detected in Al₃Ti brazed with pure aluminium. In Fig. 6, silicon was analysed by WDX line analysis. From the above-mentioned results, the solution of silicon into Al₃Ti from the filler metal is thought to suppress the growth rate of Al₃Ti.

Fig. 7 shows SEM and EDX line analyses of brazed interfaces for Al-3Si and Al-10Si filler metals. The formation of multiple compounds is confirmed by the difference in silicon content. All compounds contained silicon as in Al-0.1 to 0.8% Si filler metals. Therefore, in silicon-bearing filler metals, silicon was detected in intermetallic compounds formed during brazing. Within the range of 0 to 0.8% Si, the thickness of the compound decreased with silicon content whereas further addition increased the thickness, which corresponds to multiple intermetallic formation.

The silicon content in Al₃Ti and Ti₉Al₂₃-type compounds was measured by WDX point analysis. The results are summarized in Table III. Although the measurements were carried out on relatively large compounds, the detected area in some compounds might be larger than that of the compound. Therefore the measured values had some degree of scattering and it is difficult to give the exact values. In Table III, the mean values of more than five measurements are listed.

TABLE II Effect of silicon content on intermetallic compounds and layer thickness of Ti/Ti joints brazed at 600°C for 3 min

Filler metal	Silicon content (wt %)	Intermetallic compound layer	
		Thickness (μ m)	Type of compound
Pure Al	0.002	13.3	Al ₃ Ti
Al-0.1Si	0.14	3.7	Al ₃ Ti
Al-0.3Si	0.32	3.3	Al ₃ Ti
Al-0.8Si	0.84	2.6	Al ₃ Ti
Al-3Si	3.0	6.2	Ti ₉ Al ₂₃ , Al ₃ Ti, Ti ₇ Al ₅ Si ₁₂
Al-10Si	10.1	7.6	Ti ₉ Al ₂₃ , Ti ₇ Al ₅ Si ₁₂ , Al ₃ Ti

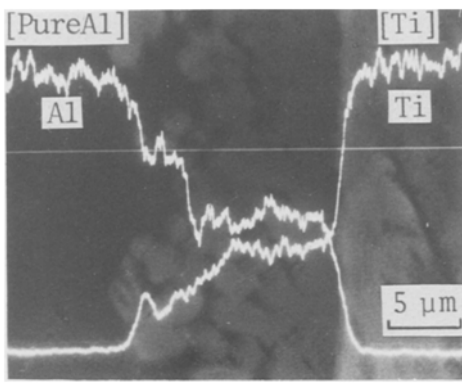

Figure 5 SEM and EDX line analyses on cross-section of Ti/Ti joint brazed with pure aluminium.

In Al–0.1 to 0.8% Si filler metals, Al_3Ti contained 1 to 3 at % Si. In Al–3Si filler metals somewhat higher values were obtained; the mean value was about 7 at %. In this filler metal the titanium concentration in the Al_3Ti -type compound was 25 at %, so that the compound can be expressed as $(\text{Al}, \text{Si})_3\text{Ti}$. The titanium contents of Al_3Ti -type compounds formed by Al–0.1 to 0.8% Si filler metals were not exactly 25 at %; however, the compounds might be expressed as $(\text{Al}, \text{Si})_3\text{Ti}$ from the above results.

From the observed values of $\text{Ti}_9\text{Al}_{23}$ -type compounds formed by Al–10Si filler metal, the compound might be also expressed as $\text{Ti}_9(\text{Al}, \text{Si})_{23}$ although the measured composition coincided with $\text{Ti}_9\text{Al}_{21}\text{Si}_3$.

3.2.2. Growth rate of Al_3Ti

The growth rate of Al_3Ti was investigated in pure aluminium and Al–0.8Si filler metals. The compound

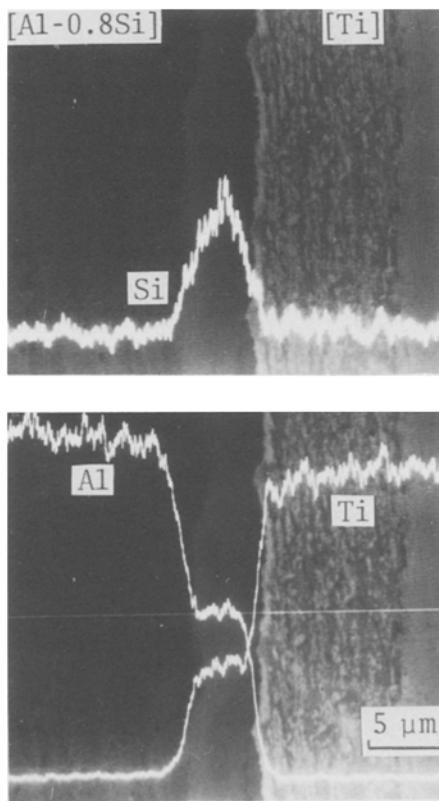

Figure 6 SEM and WDX line analyses for silicon and EDX line analysis for titanium and aluminium on Ti/Ti joint interface brazed with Al–0.8% Si filler metal.

TABLE III Composition of intermetallic compounds formed during brazing with silicon-bearing filler metals

Filler metal	Composition (at %)			Measured type of intermetallic compound
	Si	Al	Ti	
Al–0.1Si	1.5	74.5	24	Al_3Ti (25 at % Ti)
Al–0.3Si	3	72	25	Al_3Ti (25 at % Ti)
Al–0.8Si	1	74.5	24.5	Al_3Ti (25 at % Ti)
Al–3Si	6.5	68.5	25	Al_3Ti (25 at % Ti)
Al–10Si	10	63	27	$\text{Ti}_9\text{Al}_{23}$ (28 at % Ti)

grew linearly with time in the temperature range between 670 and 700°C:

$$d = kt + a$$

where d = thickness of intermetallic compound layer (μm), k = growth rate constant ($\mu\text{m min}^{-1}$), t = holding time at brazing temperature (min), a = constant (μm). The constant a is the thickness at $t = 0$, which corresponds to growth until the specimen reaches the brazing temperature. The plots of k in logarithmic scale against $1/T$ (T : absolute temperature) are shown in Fig. 8. The growth rate constant in pure aluminium is more than one order larger than for Al–0.8Si. The plot shows a straight line. Activation energies calculated from the slopes of the lines are also obtainable from Fig. 8; 166 kJ mol^{-1} for pure aluminium and 359 kJ mol^{-1} for Al–0.8Si.

The activation energies for various reactions are listed in Table IV. The values from the present work are larger than the activation energies for diffusion of titanium in molten aluminium [9], for dissolution of titanium into molten aluminium [10] and for diffusion of aluminium in α -Ti [11, 12]. However, the value in pure aluminium is nearly equal to that of the growth of Al_3Ti in a solid Ti/Al diffusion couple [13]. In the Ti/Al diffusion couple [13], the growth rate of Al_3Ti is expressed as $d^n = kt$ (d = thickness of Al_3Ti , k = constant, t = time and $n = 1.1 \pm 0.1$). Since the two reactions show similar growth rates and activation energies, the possibility that the rate-controlling process of the present work is the same as in the Ti/Al diffusion couple is suggested.

On the other hand, the values in Al–0.8Si is much larger than the activation energy for the interdiffusion of aluminium and titanium in Al_3Ti [11]. Therefore in Al–0.8Si the reaction might be controlled at the interface of dissimilar phases, dissolved silicon in Al_3Ti might strongly combine with titanium because of their high affinity.

Fig. 9 shows a part of the aluminium–titanium binary phase diagram at the aluminium-rich side. During the reaction between molten pure aluminium and solid titanium at the brazing temperature, the composition of molten aluminium shifts from Point A to Point B due to the dissolution of titanium base metal into molten aluminium. In brazing the volume of aluminium filler metal is limited, and the molten aluminium will be saturated with titanium at Point B. Further holding crystallizes the coexisting phase Al_3Ti . In general, crystallization might be observed before the concentration of filler metal reaches Point B if the saturated phase is formed at the surface of

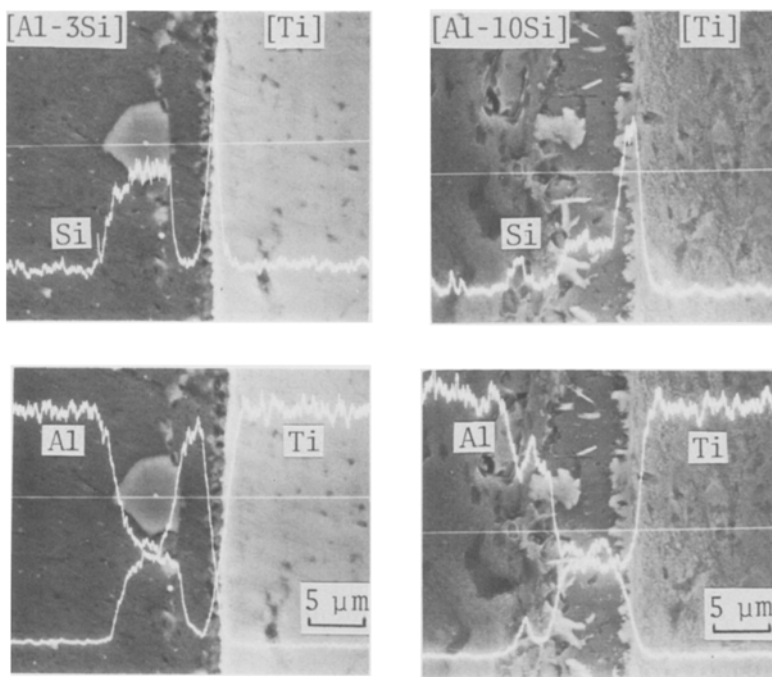

Figure 7 SEM and EDX line analyses on Ti/Ti joint interfaces brazed with Al-3Si and Al-10Si.

titanium base metal and the diffusion of this layer is limited.

Therefore, the following three reasons are suggested for the suppression mechanism of intermetallic compound growth by silicon addition to aluminium filler metal. Firstly, the dissolution rate of titanium into molten aluminium filler metal is suppressed. Secondly, saturated concentration is enlarged, i.e. the liquidus and therefore Point B are shifted to the right. Finally, the growth of intermetallic compound itself is suppressed.

To clarify the most dominant factors, the effect of silicon addition to aluminium filler metals on the dissolution rate of titanium into molten aluminium and the saturation concentration are investigated. The dissolution tests were carried out by immersion of the titanium wire into a molten aluminium bath at 670 to 700°C for up to 25 min. The mass of the molten aluminium bath was 700 g. The initial diameter of titanium wire was 0.25 mm. The wire diameter decreased linearly with holding time at each temperature. Fig. 10 shows the dissolution rate of titanium wire radius when immersed in molten aluminium and Al-0.8Si. From the figure, the dissolution rate in pure aluminium is 14 to 20% larger than in Al-0.8Si.

The apparent activation energies, obtained from Fig. 10, are 138 kJ mol^{-1} for pure aluminium and 125 kJ mol^{-1} for Al-0.8Si; the values are nearly equal to that for the diffusion of aluminium in α -titanium,

115 or 126 kJ mol^{-1} [11, 12]. However, the values obtained are significantly larger than for the diffusion of titanium in molten aluminium (81.2 kJ mol^{-1} [9]) and the dissolution of titanium in molten aluminium ($92 \pm 8 \text{ kJ mol}^{-1}$ [10]).

Silicon addition to an aluminium bath reduced the dissolution rate of solid titanium by about 15%; however, the difference in growth rate constant of the intermetallic compound layer is much larger, more than one order larger. Mackowiak and Shreir [10] reported that the growth rate of Al_3Ti in molten aluminium gave an index of the dissolution rate, but this is not the case in these experiments.

Small additions of titanium into an aluminium bath remarkably reduced the dissolution rate of the radius of titanium wire, $0.93 \mu\text{m min}^{-1}$ for a pure aluminium bath and $1.0 \mu\text{m min}^{-1}$ for an Al-0.8Si bath at 685°C. In this instance each bath contained about 0.17% Ti, which is nearly at the liquidus temperature (saturated concentration of titanium) at 685°C. The difference in dissolution rate between pure aluminium and Al-0.8Si is very small. Therefore a significant difference in saturation concentration is not expected.

From the above results, even though the dissolution rate in pure aluminium is about 15% larger than in Al-0.8Si, the difference in the growth rates of intermetallic compound layers between the two filler metals is more than one order of magnitude; therefore the difference is not explained by the dissolution rate.

TABLE IV Activation energies for various reactions

Reaction	Activation energy (kJ mol^{-1})	Reference
Diffusion of titanium in molten aluminium	81.2	[9]
Dissolution of titanium into molten aluminium	92 ± 8	[10]
Diffusion of aluminium in α -Ti	115, 126	[11, 12]
Growth of Al_3Ti in solid Al/Ti diffusion couple	179 ± 5.9	[13]
Interdiffusion of aluminium and titanium in Al_3Ti	256.0	[11]
Molten pure aluminium/solid α -Ti	166	This work
Molten Al-0.8Si/solid α -Ti	359	This work

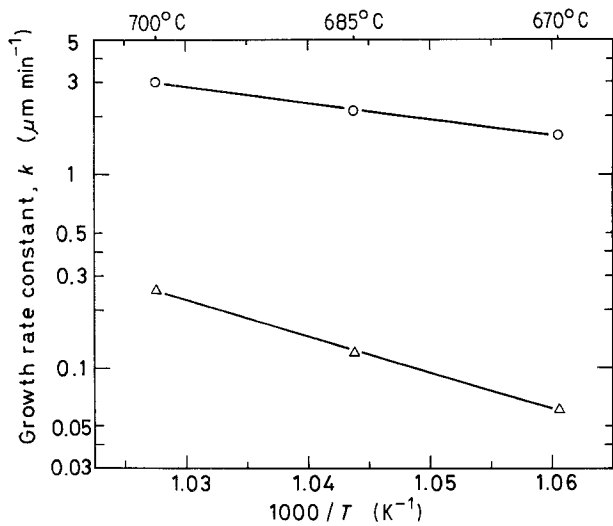

Figure 8 Plots of growth rate constant, k , on logarithmic scale against $1/T$. (○) Pure aluminium ($Q = 166 \text{ kJ mol}^{-1}$), (Δ) Al-0.8Si ($Q = 359 \text{ kJ mol}^{-1}$).

It can be concluded that the solution of silicon in Al_3Ti suppressed the growth rate of Al_3Ti itself.

In Ti_3Al , titanium can move easily, but in aluminium-rich compounds aluminium can move easily [14]. Therefore the movement of titanium will be greatly decreased by the solution of silicon in Al_3Ti , which might lead to the reduction in growth rate of Al_3Ti .

3.2.3. Joint strength

Fig. 11 shows the effect of brazing temperature and holding time on Ti/Ti joint strength when brazed with pure aluminium or Al-0.8Si. The effect of brazing temperature on joint strength is relatively small for the brazing time of 3 min, but the fracture load slightly reduced with a rise in temperature, and the tendency is a little more clear in pure aluminium than in Al-0.8Si. In Al-0.8Si filler metal, all joints fractured at the base metal at 670°C. The number of base-metal

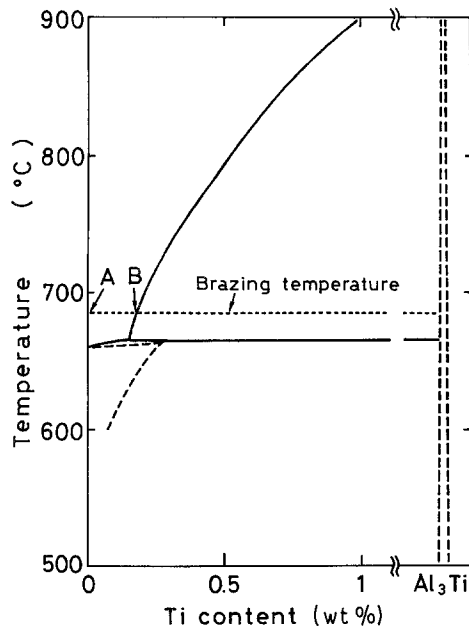

Figure 9 Partial phase diagram of Al-Ti system.

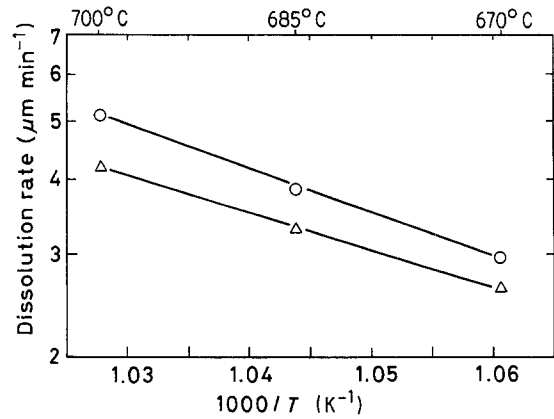

Figure 10 Plots of dissolution rate of titanium wire radius on logarithmic scale against $1/T$. (○) Pure aluminium ($Q = 138 \text{ kJ mol}^{-1}$), (Δ) Al-0.8Si ($Q = 125 \text{ kJ mol}^{-1}$).

fractures decreased with increasing the brazing temperature. Al-0.8Si filler metal maintained a higher strength and higher proportion of base-metal fracture than pure aluminium for high-temperature brazing.

Prolonged brazing drastically reduced the joint strength especially in pure aluminium. Brazing for more than 10 min yielded a remarkable decrease in joint strength when brazed with pure aluminium. Joints brazed with Al-0.8Si maintained a relatively high strength (about 2.7 kN for up to 20 min at 700°C); however, in pure aluminium filler metals the strength was about 0.3 kN after brazing at 700°C for 20 min. In pure aluminium filler metal, the loss of molten filler metal is larger than in Al-0.8Si filler metal due to the higher reaction rate with titanium base metal and wide spreading on the base metal; this will be the main reason for the lower joint strength in pure aluminium at high temperatures and a long time of brazing.

From the point of view of the reliability of joints, base metal fracture is preferable to joint fracture. Accordingly the use of silicon-bearing filler metal, namely a commercial aluminium alloy such as A3003, and brazing at low temperatures and short holding time are recommended.

4. Conclusions

The effects of aluminium filler metal composition on intermetallic compound formation during the brazing of Al/Ti and Ti/Ti joint was investigated. The results obtained are summarized as follows:

1. In Al/Ti joints, Al_3Ti was mainly formed in Al-Cu-Sn and Al-Ag-Cu, but $\text{Ti}_7\text{Al}_5\text{Si}_{12}$ was the main compound in Al-10Si-1Mg filler metal. The latter gave about two times higher strength than the former ones.

2. In Ti/Ti joints, pure aluminium filler metal exhibited the maximum thickness of intermetallic layer, and the addition of other elements reduced the layer thickness. Above all, a small addition of silicon up to 0.8% in aluminium filler metal remarkably reduced the growth rate of Al_3Ti .

3. Al-0.8Si filler metal showed a higher joint strength and a higher proportion of base-metal

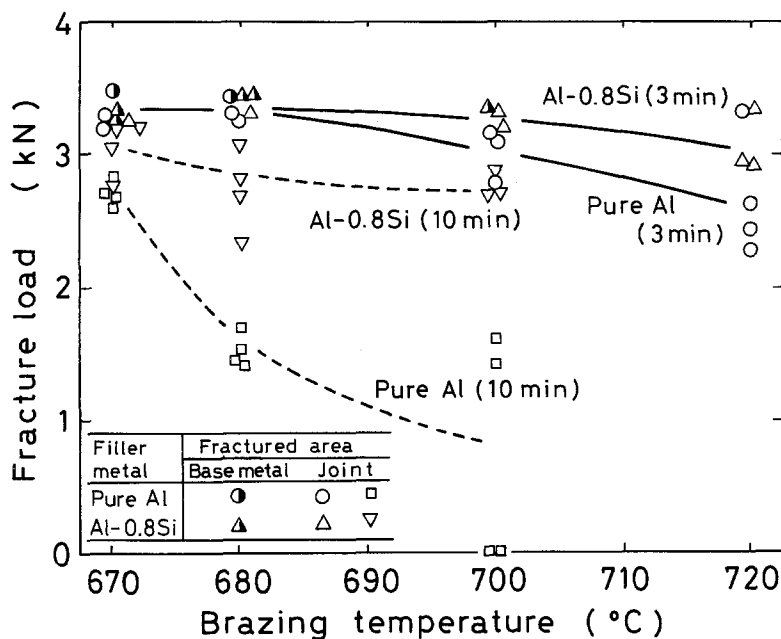

Figure 11 Effect of brazing conditions on joint strength of Ti/Ti joint with 9 mm width and 4 mm lap length.

fractures and pure aluminium after high-temperature brazing and long time brazing.

4. In silicon-bearing filler metals, silicon was detected in intermetallic compounds. The solution of silicon in Al_3Ti is believed to reduce the thickness of Al_3Ti .

5. Al-3Si and Al-12Si filler metals formed $Ti_7Al_5Si_{12}$, Ti_9Al_{23} and Al_3Ti , each compound containing silicon.

Acknowledgements

The authors wish to thank Mr H. Nakamura for experimental work, Mr H. Kawase of Fukawa Aluminum Co. Ltd and Dr T. Nishimura of Kobe Steel Ltd. for gifts of experimental materials.

References

1. H. L. MEREDITH, *Weld. J.* **33** (1954) 537.
2. J. F. RUDY, R. M. NECHELES and H. SCHWARTZ-BART, *ibid.* **38** (1959) 202-s.
3. K. M. WEIGERT, *ibid.* **41** (1962) 84-s.
4. R. A. LONG and R. R. RUPPENDER, *ibid.* **33** (1954) 1087.
5. W. LAN, *ibid.* **61** (1982) 23.
6. R. R. WELLS, *ibid.* **55** (1976) 20-s.
7. S. D. ELROD, D. T. LOVELLAND and R. A. DAVIS, *ibid.* **52** (1973) 425-s.
8. M. HANSEN, in "Constitution of Binary Alloys", 2nd Edn (McGraw-Hill, New York, 1958) pp. 58, 139, 642.
9. Diffusion Information Center, Ohio. "Diffusion Data", Vol. 5 (Trans. Tech. Pub., Ohio, 1971) p. 615.
10. J. MACOWIAK and L. L. SHREIR, *J. Less-common Metals* **15** (1968) 341.
11. Diffusion Information Center, Ohio. "Diffusion Data", Vol. 15 (Trans. Tech. Pub., Ohio, 1981) p. 121.
12. Diffusion Information Center, Ohio. "Diffusion Data", Vol 6 (Trans. Tech. Pub., Ohio, 1972) p. 552.
13. E. SHEUL and H. WURSE, *Z. Metallkde* **29** (1937) 224.
14. F. J. J. Van LOO and G. D. RIECK, *Acta Metall.* **21** (1973) 73.

Received 28 April
and accepted 6 July 1987